

MS-9A89

Industrial Data Machine



Copyright and Trademarks Notice

Copyright © Micro-Star Int'l Co., Ltd. All rights reserved. The MSI logo used is a registered trademark of Micro-Star Int'l Co., Ltd. All other marks and names mentioned may be trademarks of their respective owners. No warranty as to accuracy or completeness is expressed or implied. MSI reserves the right to make changes to this document without prior notice.

Revision History

Revision	Date
V1.1	2019/02

Technical Support

If a problem arises with your product and no solution can be obtained from the user's manual, please contact your place of purchase or local distributor. Alternatively, please visit <https://www.msi.com/support/> for further guidance.

Safety Instructions

- Always read the safety instructions carefully.
- Keep this User's Manual for future reference.
- Keep this equipment away from humidity.
- Lay this equipment on a reliable flat surface before setting it up.
- The openings on the enclosure are for air convection hence protects the equipment from overheating. **DO NOT COVER THE OPENINGS.**
- Make sure the voltage of the power source and adjust properly 110/220V before connecting the equipment to the power inlet.
- Place the power cord such a way that people can not step on it. Do not place anything over the power cord.
- Always Unplug the Power Cord before inserting any add-on card or module.
- All cautions and warnings on the equipment should be noted.
- Never pour any liquid into the opening that could damage or cause electrical shock.
- If any of the following situations arises, get the equipment checked by service personnel:
 - ▶ The power cord or plug is damaged.
 - ▶ Liquid has penetrated into the equipment.
 - ▶ The equipment has been exposed to moisture.
 - ▶ The equipment does not work well or you can not get it work according to User's Manual.
 - ▶ The equipment has dropped and damaged.
 - ▶ The equipment has obvious sign of breakage.
- **DO NOT LEAVE THIS EQUIPMENT IN AN ENVIRONMENT UNCONDITIONED, STORAGE TEMPERATURE ABOVE 60°C, IT MAY DAMAGE THE EQUIPMENT.**

警告使用者:

此為甲類資訊技術設備，於居住環境中使用時，可能會造成射頻擾動，在此種情況下，使用者會被要求採取某些適當的對策。

Chemical Substances Information

In compliance with chemical substances regulations, such as the EU REACH Regulation (Regulation EC No. 1907/2006 of the European Parliament and the Council), MSI provides the information of chemical substances in products at:

https://www.msi.com/html/popup/csr/evmtprtt_pcm.html

Battery Information



European Union:

Batteries, battery packs, and accumulators should not be disposed of as unsorted household waste. Please use the public collection system to return, recycle, or treat them in compliance with the local regulations.



廢電池請回收

Taiwan:

For better environmental protection, waste batteries should be collected separately for recycling or special disposal.



California, USA:

The button cell battery may contain perchlorate material and requires special handling when recycled or disposed of in California.

For further information please visit:

<https://www.dtsc.ca.gov/hazardouswaste/perchlorate/>

Danger of explosion if battery is incorrectly replaced. Replace only with the same or equivalent type recommended by the manufacturer.

CE Conformity

Hereby, Micro-Star International CO., LTD declares that this device is in compliance with the essential safety requirements and other relevant provisions set out in the European Directive.



FCC-A Radio Frequency Interference Statement

This equipment has been tested and found to comply with the limits for a Class A digital device, pursuant to Part 15 of the FCC Rules. These limits are designed to provide reasonable protection against harmful interference when the equipment is operated in a commercial environment. This equipment generates, uses and can radiate radio frequency energy and, if not installed and used in accordance with the instruction manual, may cause harmful interference to radio communications. Operation of this equipment in a residential area is likely to cause harmful interference, in which case the user will be required to correct the interference at his own expense.



Notice 1

The changes or modifications not expressly approved by the party responsible for compliance could void the user's authority to operate the equipment.

Notice 2

Shielded interface cables and AC power cord, if any, must be used in order to comply with the emission limits.

This device complies with Part 15 of the FCC Rules. Operation is subject to the following two conditions:

- 1) this device may not cause harmful interference, and
- 2) this device must accept any interference received, including interference that may cause undesired operation.

WEEE Statement

Under the European Union ("EU") Directive on Waste Electrical and Electronic Equipment, Directive 2002/96/EC, which takes effect on August 13, 2005, products of "electrical and electronic equipment" cannot be discarded as municipal waste anymore and manufacturers of covered electronic equipment will be obligated to take back such products at the end of their useful life. MSI will comply with the product take back requirements at the end of life of MSI-branded products that are sold into the EU. You can return these products to local collection points.



CONTENTS

Copyright and Trademarks Notice.....	ii
Revision History	ii
Technical Support.....	ii
Safety Instructions.....	iii
Chemical Substances Information	iv
Battery Information.....	iv
CE Conformity.....	v
FCC-A Radio Frequency Interference Statement	v
WEEE Statement	v
1. Overview.....	1-1
Package Contents.....	1-2
System Overview	1-3
System Specifications	1-8
Motherboard Jumpers.....	1-11
System Dimensions	1-14
Wall Mount	1-15
2. Getting Started.....	2-1
Installation Tools.....	2-2
System Cover.....	2-3
Memory (Optional)	2-4
mSATA Card (Optional).....	2-5
WiFi Card (Optional)	2-6
WiFi/LTE Antenna (Optional).....	2-9
LVDS Cable (Optional).....	2-10
MS-99C0 LVDS to DVI-I Converter Board (Optional)	2-12
2.5" SSD/HDD.....	2-14
Wall Mount	2-16
DIN Rail Mount 1.....	2-18
DIN Rail Mount 2 (Optional).....	2-20
VESA Mount (Optional).....	2-21
3. BIOS Setup.....	3-1
Entering Setup	3-2
The Menu Bar	3-4
Main	3-5
Advanced	3-6
Boot.....	3-12
Security	3-13

Chipset	3-21
Power	3-23
Save & Exit.....	3-25
Appendix GPIO WDT BKL Programming	A-1
Abstract.....	A-2
General Purposed IO	A-3
Watchdog Timer	A-4
LVDS Backlight Brightness Control.....	A-5
SMBus Access	A-6

1 Overview

Thank you for choosing the MS-9A89, an excellent industrial data machine from MSI.

The MS-9A89's wide heatsink fanless solution eliminates the noise and the risk of fan's failure. Furthermore, it supports VESA wall-mount interface for various scenarios like digital signage, kiosk, industrial control and POS with affordable expenditure, which not only meets the demand of Industrial applications but also fulfills the needs of companies, governments and institutes for general applications.

Package Contents

1. MS-9A89 Industrial Data Machine
2. Power Adapter & Power Cord
3. Wall Mount Set
4. DIN Rail Mount Set
5. VESA Mount Set (Optional)
6. SATA Power & Signal Cable
7. Phoenix Plug-in Terminal Block
8. Jumper Caps
9. Driver/Utility Disc

* Contact your place of purchase or local distributor if any of the items is damaged or missing.

* Package contents may vary by country.

System Overview

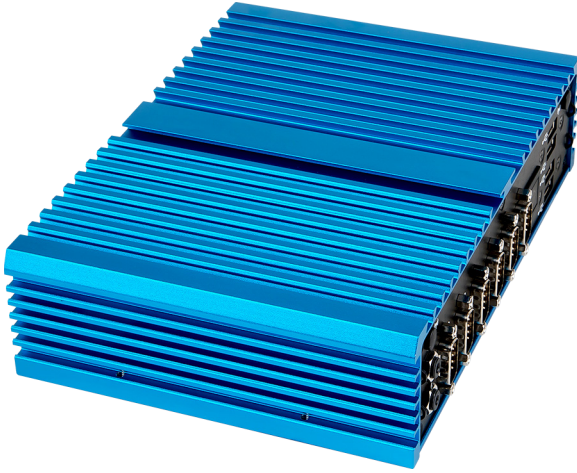

► System I/O & Controls

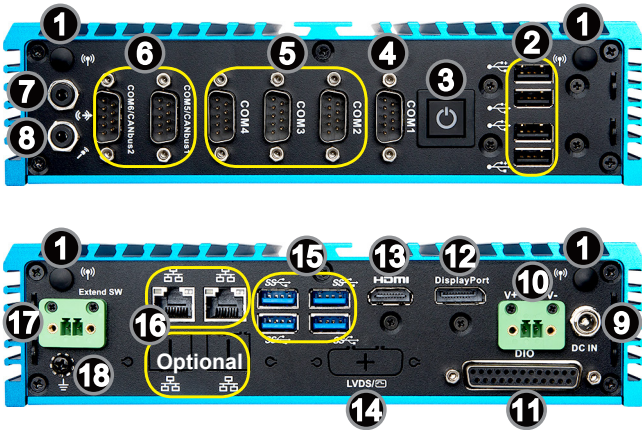

1 WLAN Antenna Connector (Optional)

This connector allows you to connect an external antenna for wireless LAN.

2 USB 2.0 Port

The USB (Universal Serial Bus) port is for attaching USB devices such as keyboard, mouse, or other USB-compatible devices.

3 Power Button

Press the button to turn the system on or off.

4 RS232/422/485 Serial Port: COM1

The serial port is a 16550A high speed communications port that sends/ receives 16 bytes FIFOs. It supports barcode scanners, barcode printers, bill printers, credit card machine, etc.

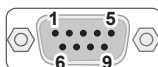

	PIN	SIGNAL	DESCRIPTION
RS232	1	NDCD	Data Carrier Detect
	2	NSIN	Signal In
	3	NSOUT	Signal Out
	4	NDTR	Data Terminal Ready
	5	GND	Signal Ground
	6	NDSR	Data Set Ready
	7	NRTS	Request To Send
	8	NCTS	Clear To Send
	9	0V/5V/12V	Power Pin

	PIN	SIGNAL	DESCRIPTION
RS422	1	422 TXD-	Transmit Data, Negative
	2	422 RXD+	Receive Data, Positive
	3	422 TXD+	Transmit Data, Positive
	4	422 RXD-	Receive Data, Negative
	5	GND	Signal Ground
	6	NC	No Connection
	7	NC	No Connection
	8	NC	No Connection
	9	0V/5V/12V	Power Pin

	PIN	SIGNAL	DESCRIPTION
RS485	1	485 TXD-	Transmit Data, Negative
	2	NC	No Connection
	3	485 TXD+	Transmit Data, Positive
	4	NC	No Connection
	5	GND	Signal Ground
	6	NC	No Connection
	7	NC	No Connection
	8	NC	No Connection
	9	0V/5V/12V	Power Pin

5

RS232 Serial Port: COM2 ~ COM4

The serial port is a 16550A high speed communications port that sends/receives 16 bytes FIFOs. It supports barcode scanners, barcode printers, bill printers, credit card machine, etc.

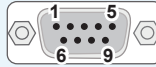

	PIN	SIGNAL	DESCRIPTION
RS232	1	ND CD	Data Carrier Detect
	2	NSIN	Signal In
	3	NSOUT	Signal Out
	4	NDTR	Data Terminal Ready
	5	GND	Signal Ground
	6	NDSR	Data Set Ready
	7	NRTS	Request To Send
	8	NCTS	Clear To Send
	9	0V/5V/12V	Power Pin

6

RS232 Serial Port / Optional CANbus Port: COM5 ~ COM6

The serial port is a 16550A high speed communications port that sends/receives 16 bytes FIFOs. It supports barcode scanners, barcode printers, bill printers, credit card machine, etc.

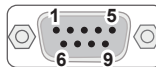

	PIN	SIGNAL	DESCRIPTION
RS232	1	ND CD	Data Carrier Detect
	2	NSIN	Signal In
	3	NSOUT	Signal Out
	4	NDTR	Data Terminal Ready
	5	GND	Signal Ground
	6	NDSR	Data Set Ready
	7	NRTS	Request To Send
	8	NCTS	Clear To Send
	9	0V/5V/12V	Power Pin

This port can also work as an optional Controller Area Network (CANbus) port to allow microcontrollers and devices to communicate with each other in applications without a host computer.

7

Line-Out Jack

This connector is provided for headphones or speakers.

8

Microphone Jack

This connector is provided for microphones.

9

Power Jack

Power supplied through this jack supplies power to the system.

Important

Your power source can either be connected to the Power Jack or the Phoenix DC Power Connector. **Avoid connecting to both simultaneously.**

10

Phoenix DC Power Connector

The system is designed with a Phoenix connector that carries DC input.

Important

Your power source can either be connected to the Power Jack or the Phoenix DC Power Connector. **Avoid connecting to both simultaneously.**

11

DIO Port

This port is provided for the Digital Input/Output (DIO) peripheral module.

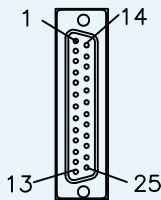
		PIN	SIGNAL	PIN	SIGNAL
1	GND	14	GND		
2	GPO0	15	GPI0		
3	GPO1	16	GPI1		
4	GPO2	17	GPI2		
5	GPO3	18	GPI3		
6	GPO4	19	GPI4		
7	GPO5	20	GPI5		
8	GPO6	21	GPI6		
9	GPO7	22	GPI7		
10	VCC5	23	VCC5		
11	NC	24	NC		
12	NC	25	NC		
13	NC				

12

DisplayPort (Supports DP++)

DisplayPort is a digital display interface standard. This connector is used to connect a monitor with DisplayPort inputs.

13

HDMI Port 

The High-Definition Multimedia Interface (HDMI) is an all-digital audio/video interface capable of transmitting uncompressed streams. HDMI supports all TV format, including standard, enhanced, or high-definition video, plus multi-channel digital audio on a single cable.

14

LVDS Port (Optional)

The LVDS (Low Voltage Differential Signal) connector provides a digital interface typically used with flat panels.

DVI Port (Optional)

Digital Visual Interface (DVI) is a video display interface developed by the Digital Display Working Group (DDWG). The digital interface is used to connect a video source, such as a video display controller, to a display device, such as a computer monitor.

15

USB 3.0 Port

The USB 3.0 port is backward-compatible with USB 2.0 devices and supports data transfer rate up to 5 Gbit/s (SuperSpeed).

16

GbE RJ45 Port

The standard RJ45 LAN jack is provided for connection to the Local Area Network (LAN). You can connect a network cable to it.

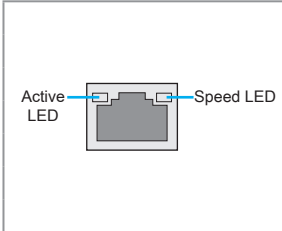
	LED	LED Status	Description
	Active LED	Off	No link
		Yellow	Linked
		Blinking	Data activity
	Speed LED	Off	10 Mbps connection
		Green	100 Mbps connection
Orange		1 Gbps connection	

17

Extend Switch Connector

This connector is provided for remote power button control.

18

Grounding Point

The Grounding Point is provided to connect a grounding wire.

System Specifications

Processor

- Intel® Kaby Lake-U Series
- Intel® Skylake-U Series

Memory

- 1 x DDR4 2133 MHz SO-DIMM slot
- Up to 16GB

Network

- 1 x Intel® I219 GbE PHY LAN
- 1 x Intel® I210 GbE LAN

Audio

- Realtek® ALC887-VD2-CG HDA Codec
- Compliant with Azalia 1.0 specs

Graphics

- HD Graphics integrated in Intel® processor
- LVDS up to 1920 x 1200 @60Hz
- HDMI up to 4096 x 2160 @24Hz
- DisplayPort up to 3840 x 2160 @60Hz (Supports DP++)
- DVI-I by MS-99C0 from LVDS (Optional), supported resolution:
 - 800 x 600 & 18bit
 - 1024 x 768 & 18bit
 - 1024 x 768 & 24bit
 - 1280 x 800 & 18bit
 - 1366 x 768 & 18bit
 - 1366 x 768 & 24bit
 - 1400 x 1050 & 24bit
 - 1600 x 900 & 24bit
 - 1600 x 1200 & 24bit
 - 1680 x 1050 & 24bit
 - 1920 x 1080 & 24bit
 - 1920 x 1200 & 24bit

Important

*For the monitor to work properly, users need to select a resolution supported by the monitor through the **Chipset** menu's **LCD Panel Type** setting in BIOS.*

Storage

- 2 x SATA 6Gb/s ports
- 1 x mSATA 6Gb/s slot (shared with Mini-PCIe2)

Expansion Slot

- 1 x Mini-PCIe1 (Full-size, with Nano SIM-Holder)
- 1 x Mini-PCIe2 (Full-size, with mSATA)

Front Panel Input/Output

- 2 x WLAN Antenna Connectors (Optional)
- 4 x USB 2.0 Ports
- 1 x Power Button
- 1 x RS232/422/485 Serial Port (COM1)
- 3 x RS232 Serial Ports (COM2 ~ COM4)
- 2 x RS232 Serial Ports / Optional CANbus Ports (COM5 ~ COM6)
- 1 x Line-Out Jack
- 1 x Microphone Jack

Rear Panel Input/Output

- 2 x WLAN Antenna Connectors (Optional)
- 1 x Power Jack
- 1 x Phoenix DC Power Connector
- 1 x DIO Port
- 1 x DisplayPort (Supports DP++)
- 1 x HDMI Port
- 1 x LVDS Port/ DVI Port (Optional)
- 4 x USB 3.0 Ports
- 2 x GbE RJ45 Ports (2 Optional Ports for Up to 4 x GbE RJ45 Ports)
- 1 x Extend Switch Connector
- 1 x Grounding Point

Power Supply

- 65 Watt Power Adapter
 - ▶ Input: 100~240Vac, 1.5A, 50~60Hz
 - ▶ Output: 19Vdc, 3.42A
 - ▶ No power consumption for COM1~6
- 90 Watt Power Adapter (Optional)
 - ▶ Input: 100~240Vac, 1.2A, 50~60Hz
 - ▶ Output: 19Vdc, 4.74A
 - ▶ Full power consumption for COM1~6

Important

Before powering on the system, recheck the adapter to ensure safety.

Dimension & Weight

- 215mm x 155mm x 55mm
- 1.55kg

Regulatory Compliance

- EMC: FCC Class A, CE, RCM, BSMI, VCCI
- Safety: BSMI
- EN50155, IEC61373
- RoHS Compliant

Environment

- Operating Temperature
 - ▶ -10 ~ 45°C (with HDD)
 - ▶ -10 ~ 60°C (with WT Memory, SSD/mSATA, MS-99C0 LVDS to DVI-I converter board)
- Storage Temperature: -20 ~ 80°C
- Humidity: 10 ~ 90% RH, non-condensing

Motherboard Jumpers

Important

Avoid adjusting jumpers when the system is on; it will damage the motherboard.

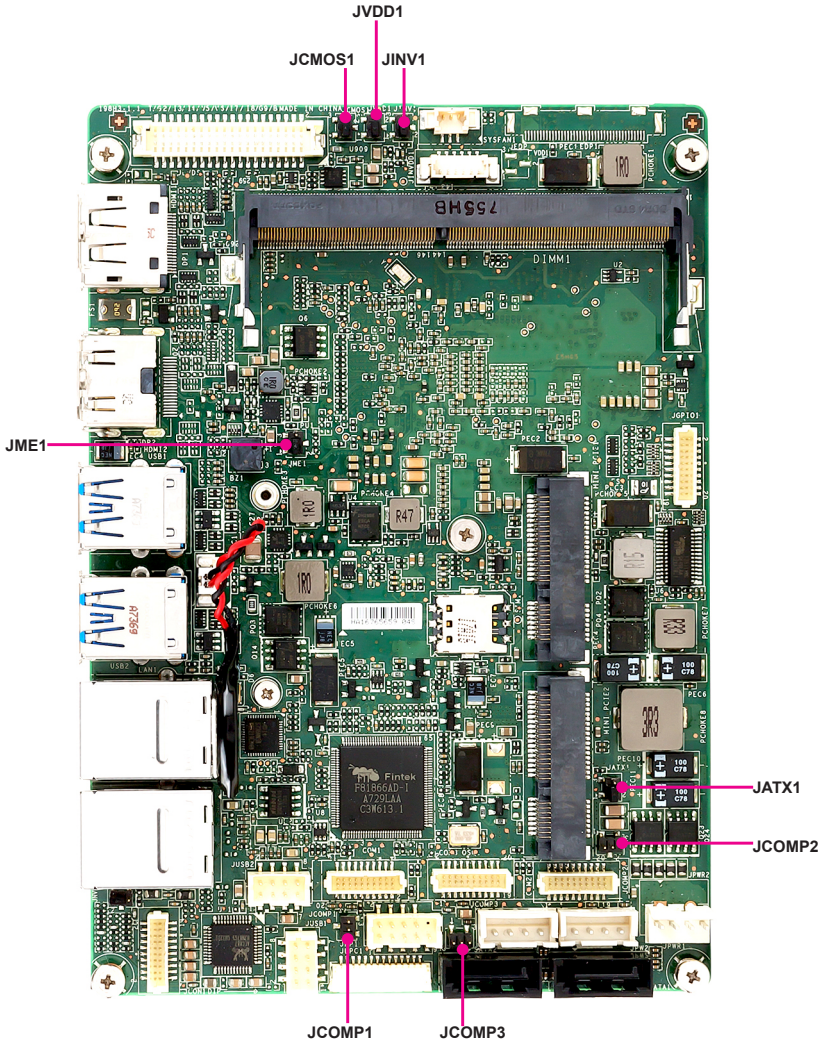

Clear CMOS Jumper: JCMOS1

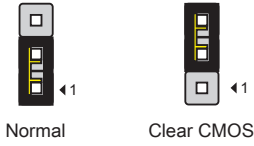

AT/ATX Select Jumper: JATX1

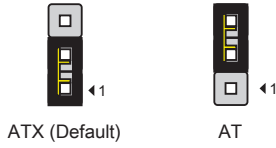

Serial Port Power Jumper: JCOMP1

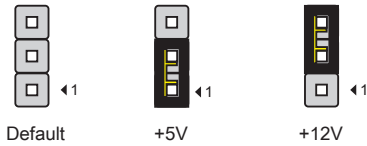

Serial Port Power Jumper: JCOMP2, JCOMP3

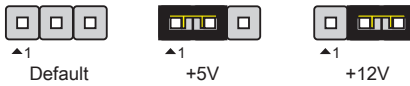

LVDS Power Jumper: JVDD1

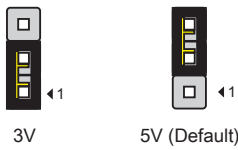

LVDS Inverter Power Jumper: JINV1

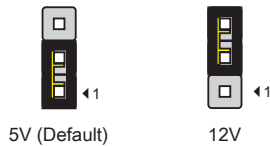

Intel ME Jumper: JME1

Disable
(Default)



Enable

System Dimensions

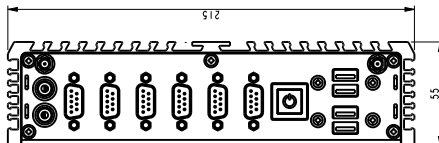
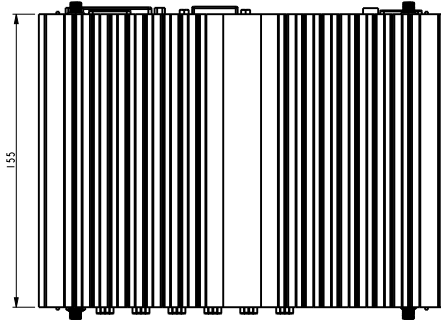
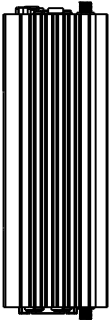
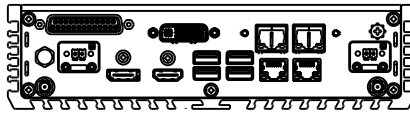
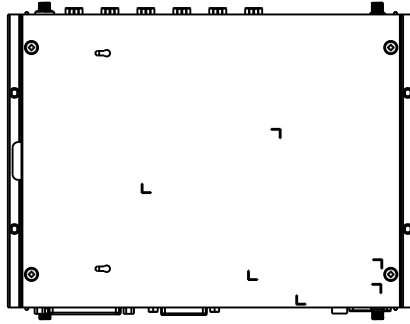

Wall Mount

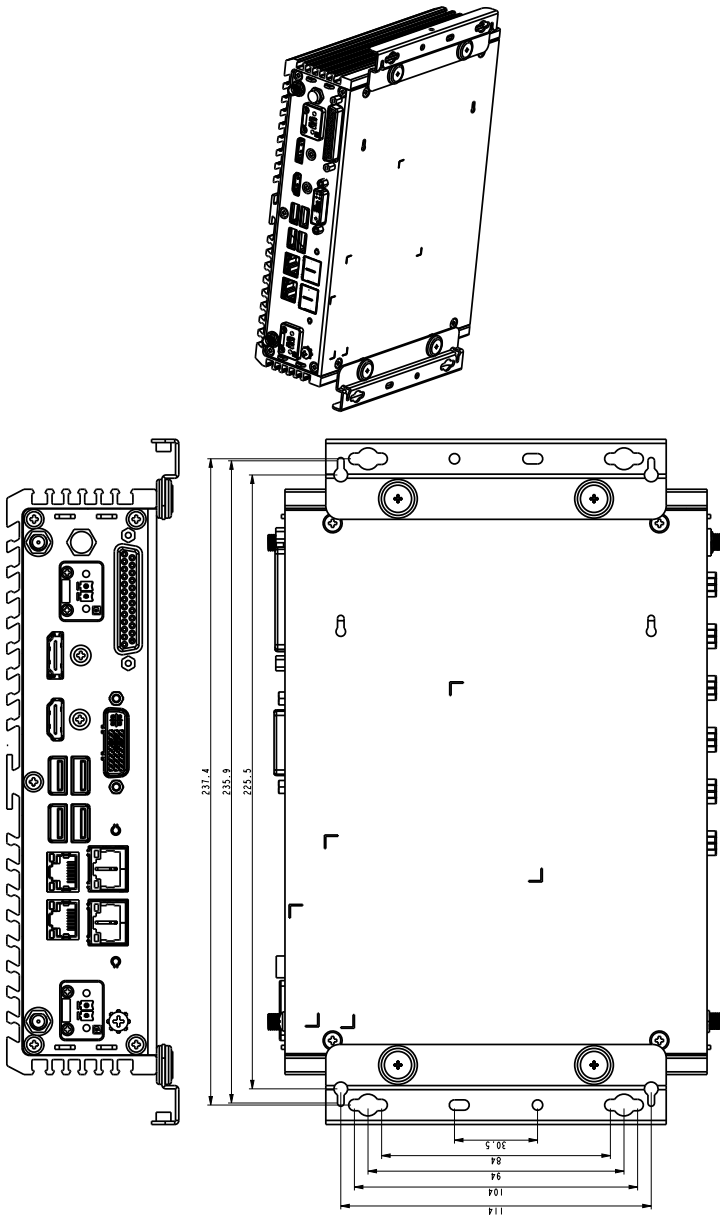

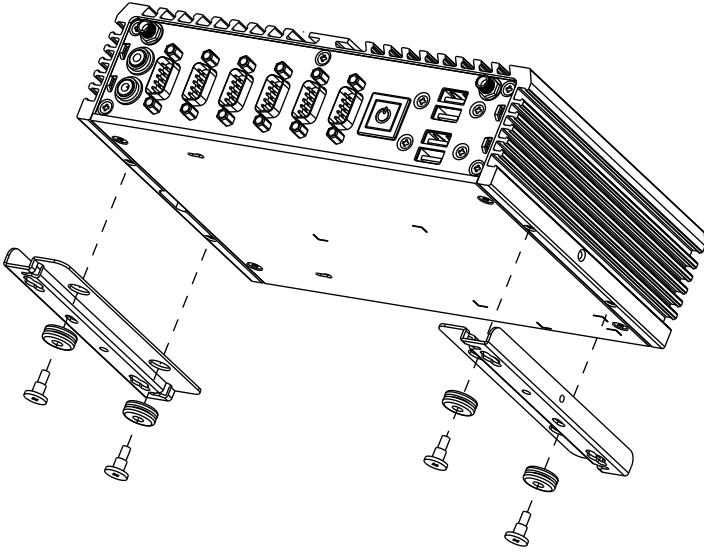

2 Getting Started





This chapter provides you with the information on hardware setup procedures. While doing the installation, be careful in holding the components and follow the installation procedures. For some components, if you install in the wrong orientation, the components will not work properly.

Use a grounded wrist strap before handling computer components. Static electricity may damage the components.

Important

Always unplug the power cord before installing any components.

Installation Tools

	<p>A Phillips (crosshead) screwdriver and a flathead screwdriver, can be used to do most of the installation. Choose one with a magnetic head would be better.</p>
	<p>Pliers, can be used as an auxiliary tool to connect some connectors or cables.</p>
	<p>Forceps, can be used to pick up tiny screws or set up the jumpers.</p>
	<p>Rubber gloves, can prevent yourself from being incised and suffering the static charge.</p>

System Cover

1. Place the system horizontally on a flat and steady surface. Locate and remove the screws that secure the system cover.



2. Lift the cover carefully upwards and remove it from the system.



Memory (Optional)

1. Locate the memory slot.

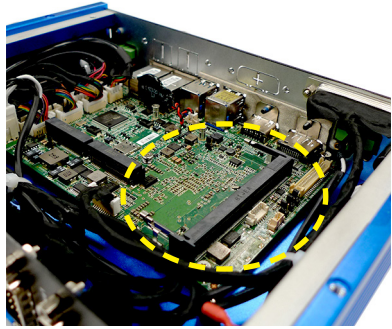

2. Align the notch on the memory with the key on the slot and insert the memory into the slot at a 45-degree angle.

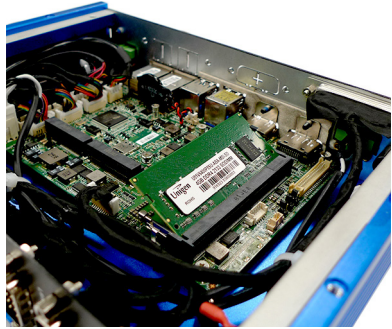

3. Push the memory gently downwards until the slot clips click and lock the memory in place.

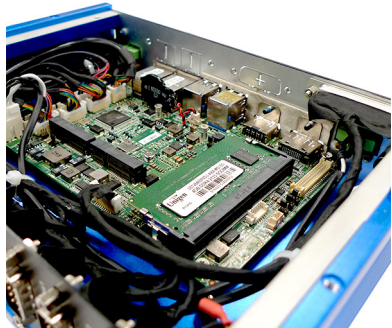

Important

- You can barely see the golden finger if the DIMM is properly inserted in the DIMM slot.
- To uninstall the DIMM, flip the slot clips outwards and the DIMM will be released instantly.

mSATA Card (Optional)

Important

For Mini PCIe cards that draw power from the motherboard, make sure they operate at exactly the same voltage as the system power source.

1. Locate the MINI_PCIE2 slot.
Remove the screw preinstalled on the motherboard.

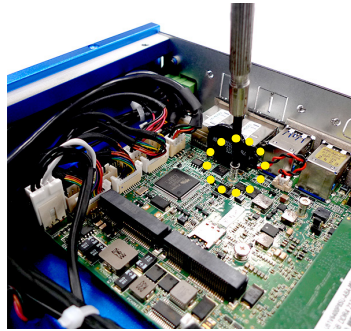

2. Insert the mSATA card into the slot at a 45-degree angle.

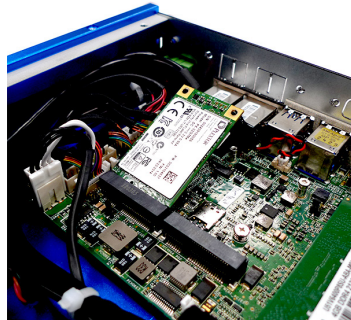

3. Push the card gently downwards and fasten it with a screw.

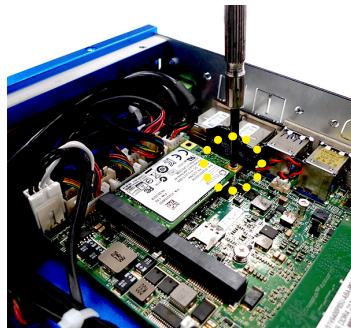

WiFi Card (Optional)

Important

For Mini PCIe cards that draw power from the motherboard, make sure they operate at exactly the same voltage as the system power source.

1. Disassemble the system rear panel.



2. Find the antenna cable modules in the accessory box.



3. Assemble the antenna cables to the system rear panel.



4. Fasten the rear panel back to the system with screws.



5. Locate the Mini PCIe slot.
Remove the Mini PCIe card screw preinstalled on the motherboard.

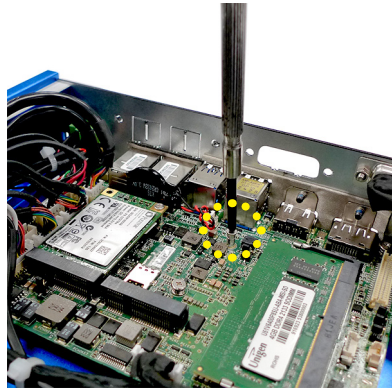

6. Insert the WiFi card into the slot at a 45-degree angle.

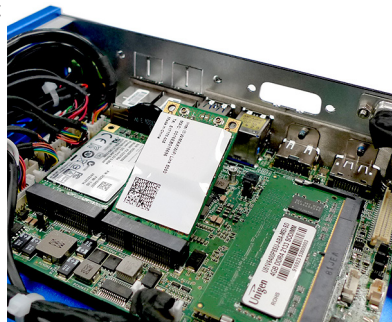

7. Push the card gently downwards and fasten it with a screw.

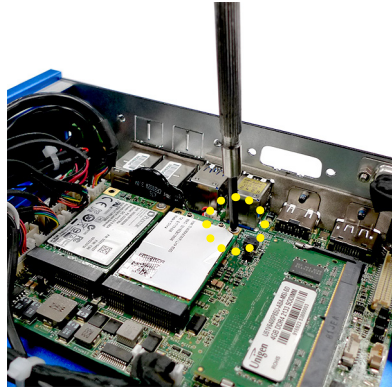

8. Connect the antenna cables.

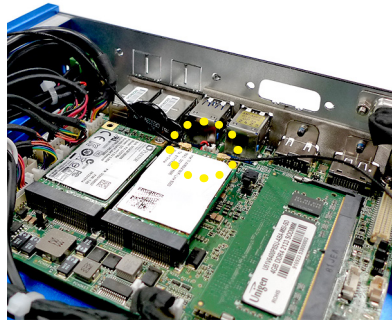

WiFi/LTE Antenna (Optional)

1. Find the WiFi/LTE antennas in the accessory box. Turn clockwise to lock the antennas and anti-clockwise to unlock.
2. Adjust the direction of the antennas for better signal reception.



LVDS Cable (Optional)

1. Remove the screw and LVDS bracket with pliers.



2. Secure the LVDS cable to the system rear panel with two hexagonal screws.

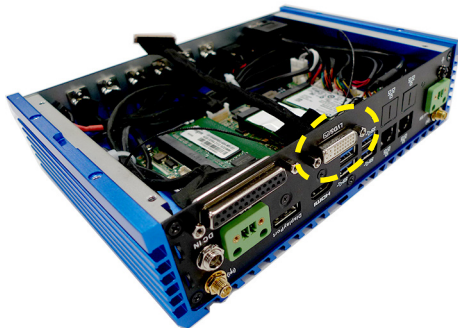

3. Connect the LVDS cable to the LVDS connector on the motherboard. Make sure the LVDS cable is inserted in the right direction.

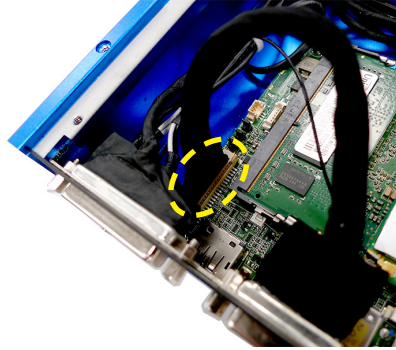
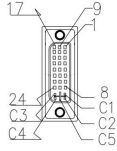

Pin	Signal	Pin	Signal	Pin	Signal
1	L_BKLT_CTRL#	13	LCD_VDD	C1	+12V
2	LVDS_BLDN	14	LCD_VDD	C3	LVDS_DETECT#_C
3	LVDSA_DATA#0	15	LVDSB_DATA#0	C3	+12V
4	LVDSA_DATA#0	16	LVDSB_DATA#0	C4	GND
5	LVDSA_DATA#1	17	LVDSB_DATA#1	C5	GND
6	LVDSA_DATA#1	18	LVDSB_DATA#1		
7	LVDSA_DATA#2	19	LVDSB_DATA#2		
8	LVDSA_DATA#2	20	LVDSB_DATA#2		
9	LVDSA_DATA#3	21	LVDSB_DATA#3		
10	LVDSA_DATA#3	22	LVDSB_DATA#3		
11	LVDSA_CLK#	23	LVDSB_CLK		
12	LVDSA_CLK#	24	LVDSB_CLK#		

MS-99C0 LVDS to DVI-I Converter Board (Optional)

1. Remove the screw and LVDS bracket with pliers.



2. Secure the MS-99C0 LVDS to DVI-I Converter Board to the system rear panel with two hexagonal screws.

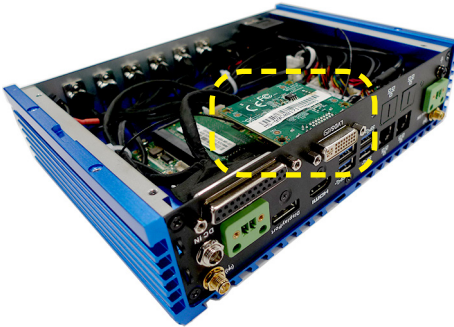

3. Connect the MS-99C0's cable to the LVDS connector on the motherboard. Make sure the cable is inserted in the right direction.

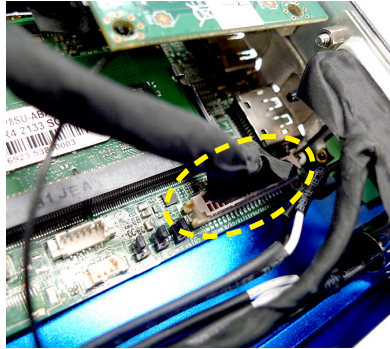

2.5" SSD/HDD

1. Flip over the system cover and locate the SSD/HDD bracket. Remove the sticker film to uncover the thermal paste.

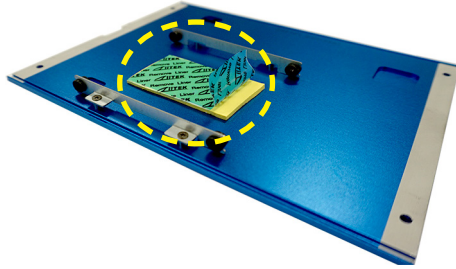

2. Check the following photo for correct orientation and place the 2.5" SSD/HDD into the bracket with screw holes aligned.
3. Tighten the screws to fix the SSD/HDD to the system cover.

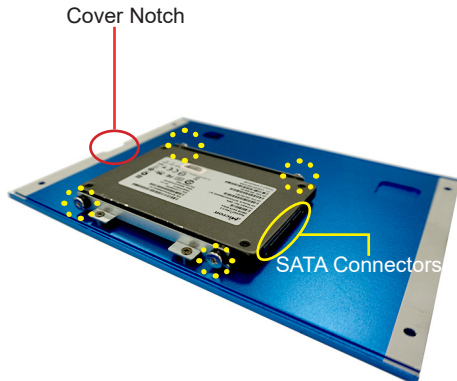

4. Connect the SATA signal & power cable to the SSD/HDD.

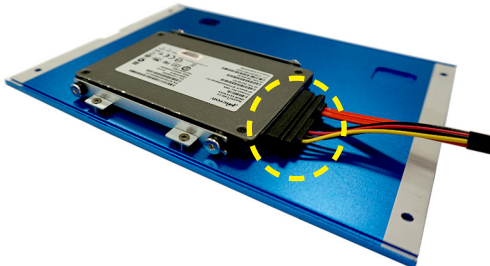

-
5. Connect the SATA signal & power cable to the motherboard.

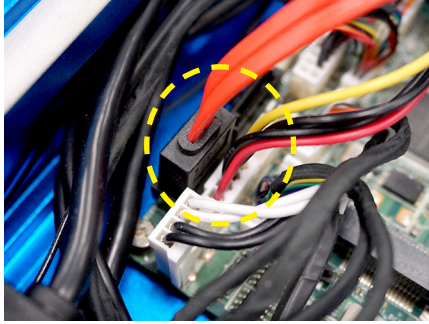

-
6. Align the notches and replace the system cover.

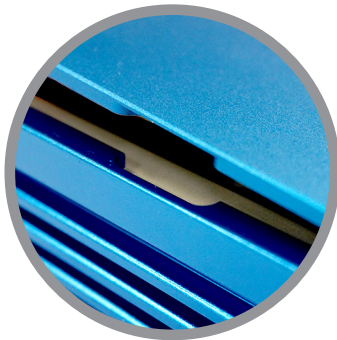

-
7. Fasten the screws to secure the system cover.



Wall Mount

1. Check the accessory box for the wall mount bracket modules.



2. Insert the rubber pads into the holes.



3. Insert the screws.



4. Flip over the system and locate the bracket screw holes.
5. Place the brackets along the sides with screw holes aligned.
6. Fasten the screws to fix the wall mount brackets.



DIN Rail Mount 1

1. Check the accessory box for the DIN rails.

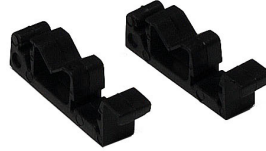

2. Put the DIN rails on the wall mount brackets with the hooks aligned.

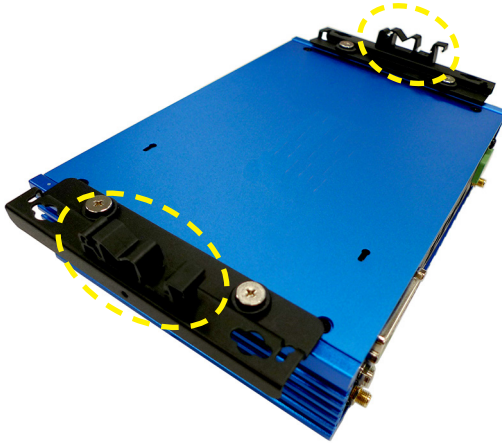

3. Insert screws through the wall mount brackets into the DIN rails and tighten until each DIN rail is secure.

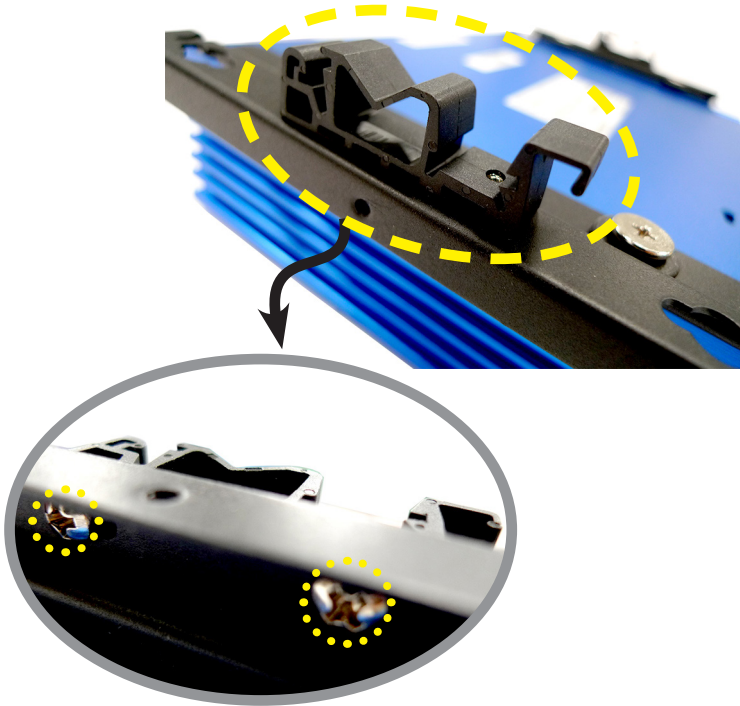

DIN Rail Mount 2 (Optional)

1. Check the VESA mount plate for the DIN rail screw holes.



2. Put the DIN rails on the VESA mount plate with screw holes aligned.
3. Insert screws through the VESA mount plate into the DIN rails and tighten until each DIN rail is secure.
4. Mount the VESA mount plate onto the system and tighten the thumbscrew of the VESA mount plate.



VESA Mount (Optional)

1. Locate the VESA mount screw holes on the intended device.
2. Fasten the VESA mount plate to the device with the supplied screws.

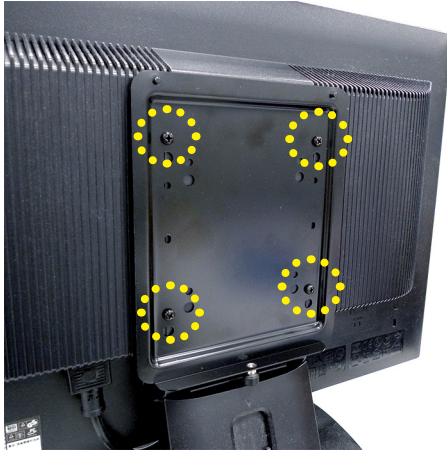

3. Mount the system onto the VESA mount plate.
4. Tighten the thumbscrew at the bottom of the VESA mount plate to secure the system.

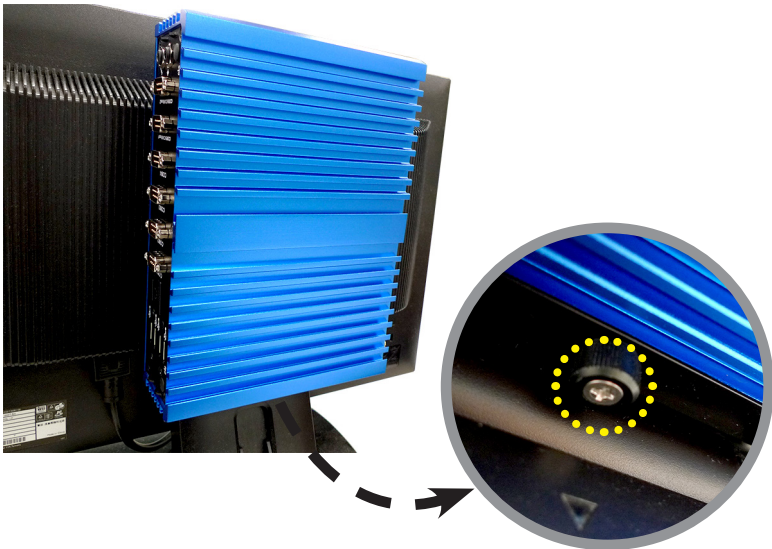

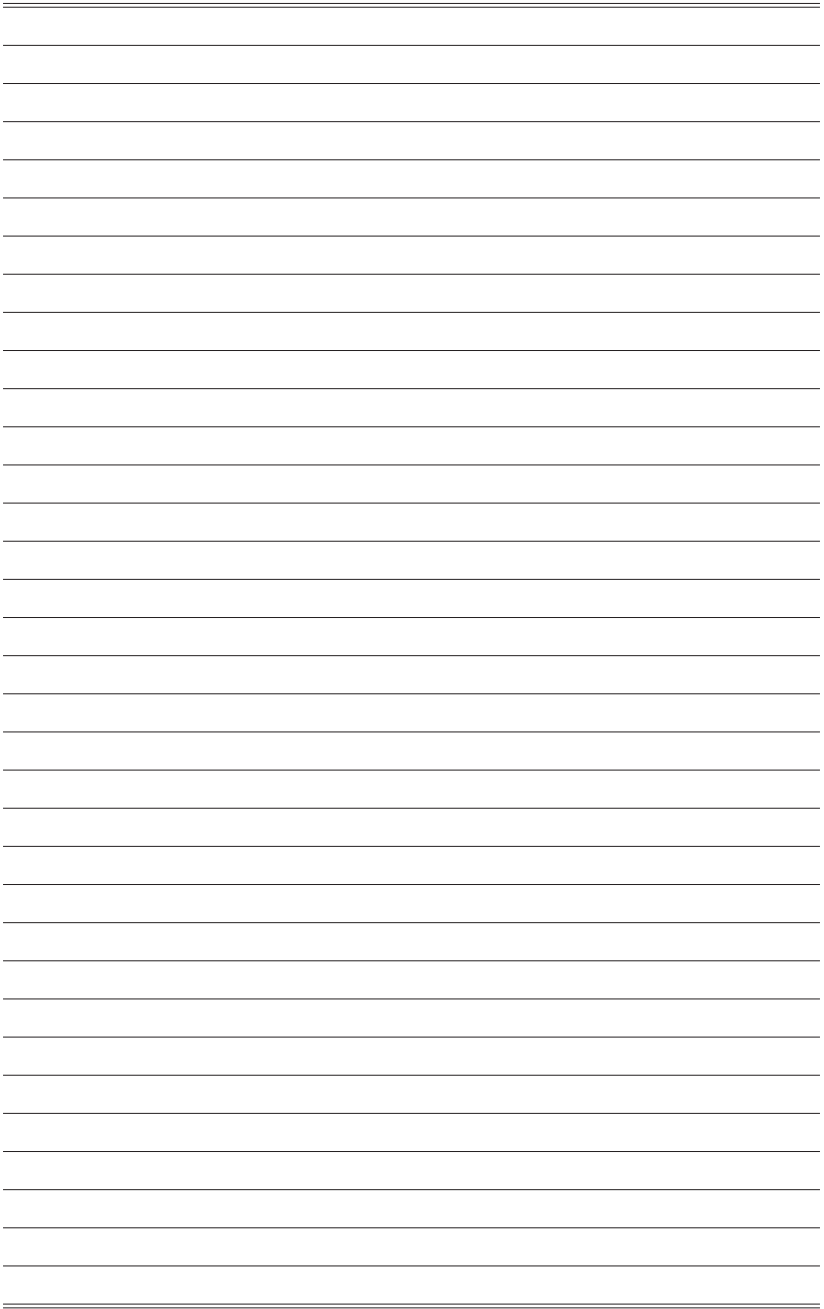

3 BIOS Setup

This chapter provides information on the BIOS Setup program and allows users to configure the system for optimal use.

Users may need to run the Setup program when:

- An error message appears on the screen at system startup and requests users to run SETUP.
- Users want to change the default settings for customized features.

Important

- *Please note that BIOS update assumes technician-level experience.*
- *As the system BIOS is under continuous update for better system performance, the illustrations in this chapter should be held for reference only.*

Entering Setup

Power on the computer and the system will start POST (Power On Self Test) process. When the message below appears on the screen, press or <F2> key to enter Setup.

Press or <F2> to enter SETUP

If the message disappears before you respond and you still wish to enter Setup, restart the system by turning it OFF and On or pressing the RESET button. You may also restart the system by simultaneously pressing <Ctrl>, <Alt>, and <Delete> keys.

Important

The items under each BIOS category described in this chapter are under continuous update for better system performance. Therefore, the description may be slightly different from the latest BIOS and should be held for reference only.

Control Keys

← →	Select Screen
↑ ↓	Select Item
Enter	Select
+ -	Change Option
F1	General Help
F7	Previous Values
F9	Optimized Defaults
F10	Save & Reset
Esc	Exit

Getting Help

After entering the Setup menu, the first menu you will see is the Main Menu.

Main Menu

The main menu lists the setup functions you can make changes to. You can use the arrow keys (↑ ↓) to select the item. The on-line description of the highlighted setup function is displayed at the bottom of the screen.

Sub-Menu

If you find a right pointer symbol appears to the left of certain fields that means a sub-menu can be launched from this field. A sub-menu contains additional options for a field parameter. You can use arrow keys (↑ ↓) to highlight the field and press <Enter> to call up the sub-menu. Then you can use the control keys to enter values and move from field to field within a sub-menu. If you want to return to the main menu, just press the <Esc >.

General Help <F1>

The BIOS setup program provides a General Help screen. You can call up this screen from any menu by simply pressing <F1>. The Help screen lists the appropriate keys to use and the possible selections for the highlighted item. Press <Esc> to exit the Help screen.

The Menu Bar

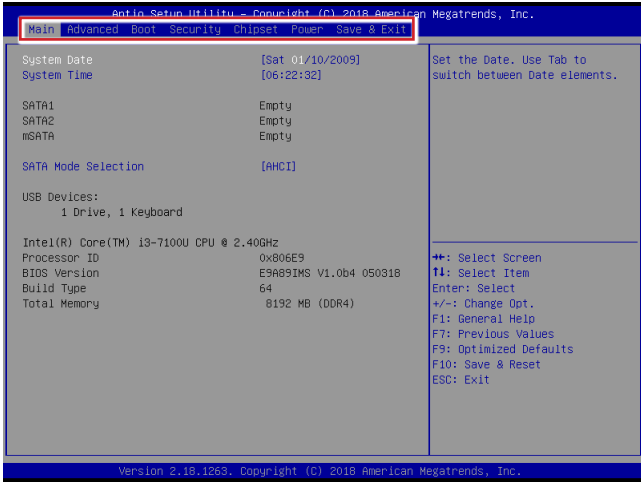

► Main

Use this menu for basic system configurations, such as time, date, etc.

► Advanced

Use this menu to set up the items of special enhanced features.

► Boot

Use this menu to specify the priority of boot devices.

► Security

Use this menu to set supervisor and user passwords.

► Chipset

This menu controls the advanced features of the onboard chipsets.

► Power

Use this menu to specify your settings for power management.

► Save & Exit

This menu allows you to load the BIOS default values or factory default settings into the BIOS and exit the BIOS setup utility with or without changes.

Main

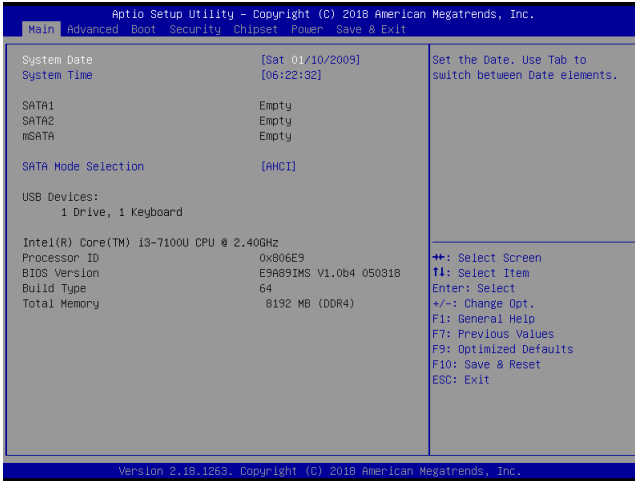

► System Date

This setting allows you to set the system date. The date format is <Day>, <Month> <Date> <Year>.

► System Time

This setting allows you to set the system time. The time format is <Hour> <Minute> <Second>.

► SATA Mode Selection

This setting specifies the SATA controller mode.

Advanced

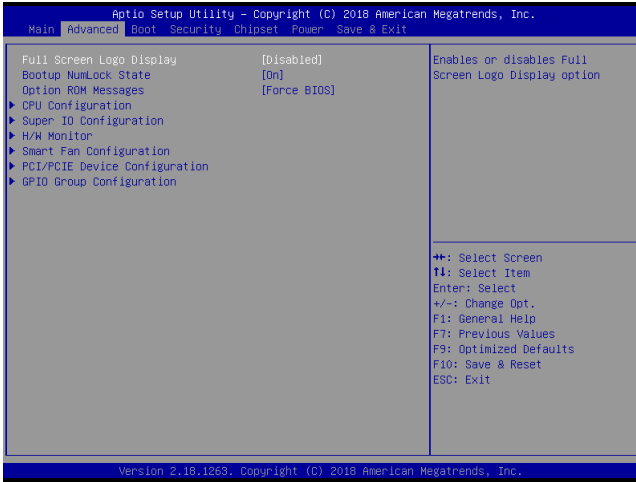

► Full Screen Logo Display

This BIOS feature determines if the BIOS should hide the normal POST messages with the motherboard or system manufacturer's full-screen logo.

When it is enabled, the BIOS will display the full-screen logo during the boot-up sequence, hiding normal POST messages.

When it is disabled, the BIOS will display the normal POST messages, instead of the full-screen logo.

Please note that enabling this BIOS feature often adds 2-3 seconds of delay to the booting sequence. This delay ensures that the logo is displayed for a sufficient amount of time. Therefore, it is recommended that you disable this BIOS feature for a faster boot-up time.

► Bootup NumLock State

This setting is to set the Num Lock status when the system is powered on. Setting to [On] will turn on the Num Lock key when the system is powered on. Setting to [Off] will allow users to use the arrow keys on the numeric keypad.

► Option ROM Messages

This item is used to determine the display mode when an optional ROM is initialized during POST. When set to [Force BIOS], the display mode used by AMI BIOS is used. Select [Keep Current] if you want to use the display mode of optional ROM.

► CPU Configuration

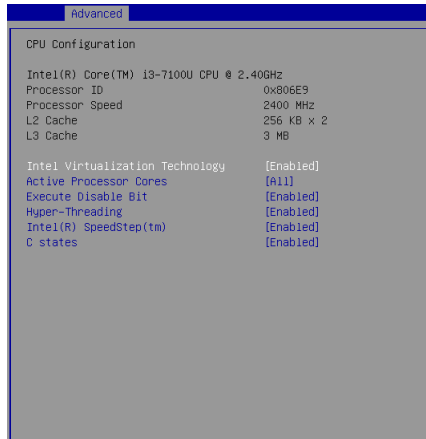

► Intel Virtualization Technology

Virtualization enhanced by Intel Virtualization Technology will allow a platform to run multiple operating systems and applications in independent partitions. With virtualization, one computer system can function as multiple “Virtual” systems.

► Active Processor Cores

This setting specifies the number of active processor cores.

► Execute Disable Bit

Intel’s Execute Disable Bit functionality can prevent certain classes of malicious “buffer overflow” attacks when combined with a supporting operating system. This functionality allows the processor to classify areas in memory by where application code can execute and where it cannot. When a malicious worm attempts to insert code in the buffer, the processor disables code execution, preventing damage or worm propagation.

► Hyper-Threading

The processor uses Hyper-Threading technology to increase transaction rates and reduces end-user response times. The technology treats the two cores inside the processor as two logical processors that can execute instructions simultaneously. In this way, the system performance is highly improved. If you disable the function, the processor will use only one core to execute the instructions. Please disable this item if your operating system doesn’t support HT Function, or unreliability and instability may occur.

► Intel(R) SpeedStep(tm)

EIST (Enhanced Intel SpeedStep Technology) allows the system to dynamically adjust processor voltage and core frequency, which can result in decreased average power consumption and decreased average heat production. When disabled, the processor will return the actual maximum CPUID input value of the processor when queried.

► C States

This setting controls the C-State (CPU Power state). C-State performance indicates the ability to run the processor in lower power states when the PC is idle. This setting enables/disables the C-State Configuration for power saving purposes.

► Super IO Configuration



► Serial Port 1/ 2/ 3/ 4/ 5/ 6

This setting enables/disables the specified serial port.

► Change Settings

This setting is used to change the address & IRQ settings of the specified serial port.

► Mode Select

Select an operation mode for the specified serial port.

► Watch Dog Timer

You can enable the system watch-dog timer, a hardware timer that generates a reset when the software that it monitors does not respond as expected each time the watch dog polls it.

► FIFO Mode

This setting controls the FIFO data transfer mode.

► Shared IRQ Mode

This setting provides the system with the ability to share interrupts among its serial ports.

► H/W Monitor

These items display the current status of all monitored hardware devices/components such as voltages, temperatures and all fans' speeds.

Advanced	
PC Health Status	
Thermal Shutdown	[Enabled]
CPU temperature	: +36 C
System temperature	: +26 C
SYSFAN1	: N/A
VCC_CORE	: +0.856 V
VCC3	: +3.279 V
VCC5	: +4.961 V
+12V	: +12.144 V
VCC3V	: +3.296 V
VSB3V	: +3.296 V
VSB5V	: +4.944 V
VBAT	: +3.120 V

► Thermal Shutdown

This setting enables/disables the thermal shutdown function for system thermal protection.

► Smart Fan Configuration

Advanced	
Configuration Smart FAN	
SYSFAN1	[Disabled]

► SYSFAN1

This setting enables/disables the Smart Fan function. Smart Fan is an excellent feature which will adjust the CPU/system fan speed automatically depending on the current CPU/system temperature, avoiding the overheating to damage your system.

► **PCI/PCIE Device Configuration**

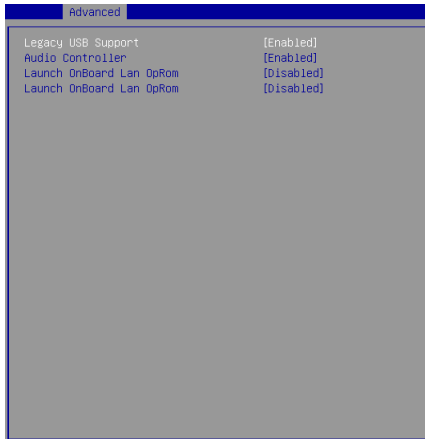

► **Legacy USB Support**

Set to [Enabled] if you need to use any USB 1.1/2.0 device in the operating system that does not support or have any USB 1.1/2.0 driver installed, such as DOS and SCO Unix.

► **Audio Controller**

This setting enables/disables the onboard audio controller.

► **Launch OnBoard LAN OpROM**

These settings enable/disable the initialization of the onboard/onchip LAN Boot ROM during bootup. Selecting [Disabled] will speed up the boot process.

▶ GPIO Group Configuration

Advanced	
GPIO Group Configuration	
GPIO0	[Low]
GPIO1	[Low]
GPIO2	[Low]
GPIO3	[Low]
GPIO4	[Low]
GPIO5	[Low]
GPIO6	[Low]
GPIO7	[Low]

▶ GPIO0 ~ GPIO7

These settings control the operation mode of the specified GPIO.

Boot

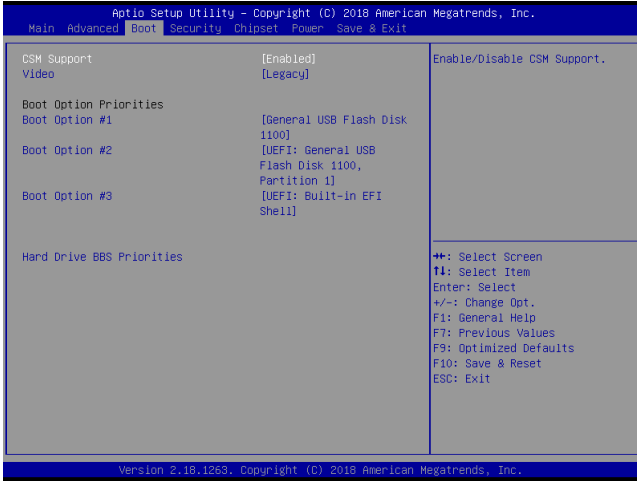

► **CSM Support**

This setting enables/disables the support for Compatibility Support Module, a part of the Intel Platform Innovation Framework for EFI providing the capability to support legacy BIOS interfaces.

► **Video**

This setting selects the video mode.

► **Boot Option Priorities**

This setting allows users to set the sequence of boot devices where BIOS attempts to load the disk operating system.

► **Hard Drive BBS Priorities**

This setting allows users to set the priority of the specified devices. First press <Enter> to enter the sub-menu. Then you may use the arrow keys (↑↓) to select the desired device, then press <+>, <-> or <PageUp>, <PageDown> key to move it up/down in the priority list.

Security

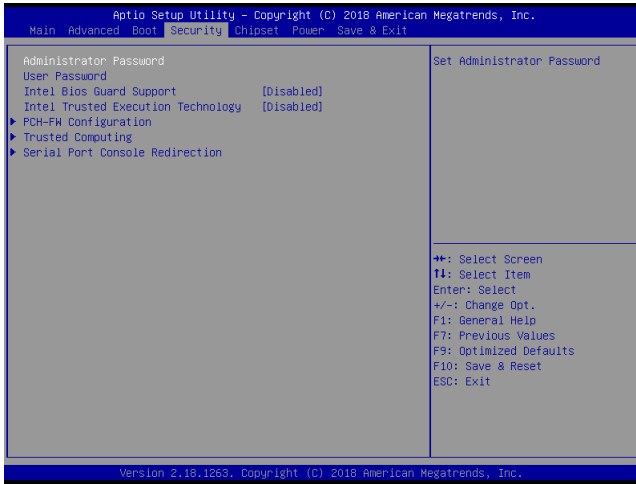

► Administrator Password

Administrator Password controls access to the BIOS Setup utility.

► User Password

User Password controls access to the system at boot and to the BIOS Setup utility.

► Intel BIOS Guard Support

Intel BIOS Guard Support ensures that updates to system BIOS flash are secure.

► Intel Trusted Execution Technology

Intel Trusted Execution Technology provides highly scalable platform security in physical and virtual infrastructures.

► PCH-FW Configuration

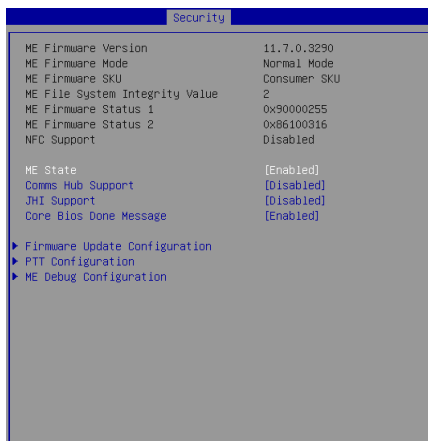

► **ME Firmware Version, ME Firmware Mode, ME Firmware SKU, ME File System Integrity Value, ME Firmware Status 1, ME Firmware Status 2, NFC Support**

These settings show the firmware information of the Intel ME (Management Engine).

► **ME State**

This setting enables/disables the ME status.

► **Comms Hub Support**

This setting enables/disables Comms Hub Support.

► **JHI Support**

This setting enables/disables JHI Support.

► **Core BIOS Done Message**

This setting enables/disables the Core BIOS Done Message.

► Firmware Update Configuration



► ME FW Image Re-Flash

This setting enables/disables the ME FW image reflash.

► Local FW Update

This setting enables/disables the local firmware update.

► PTT Configuration (Support by request)

Intel Platform Trust Technology (PTT) is a platform functionality for credential storage and key management used by Microsoft Windows.

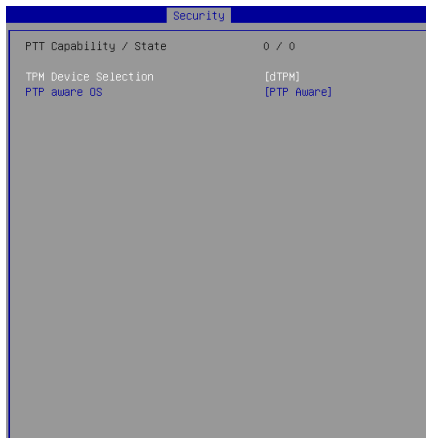

► ME Debug Configuration

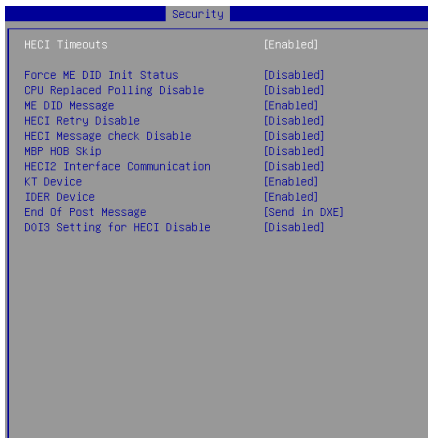

► Trusted Computing



► Security Device Support

This setting enables/disables BIOS support for security device. When set to [Disable], the OS will not show security device. TCG EFI protocol and INT1A interface will not be available.

► Serial Port Console Redirection

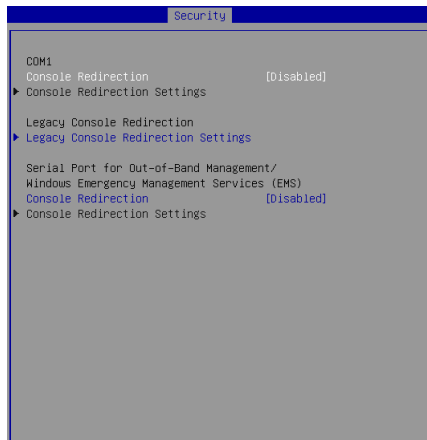

► Console Redirection

Console Redirection operates in host systems that do not have a monitor and keyboard attached. This setting enables/disables the operation of console redirection. When set to [Enabled], BIOS redirects and sends all contents that should be displayed on the screen to the serial COM port for display on the terminal screen. Besides, all data received from the serial port is interpreted as keystrokes from a local keyboard.

► **Console Redirection Settings**

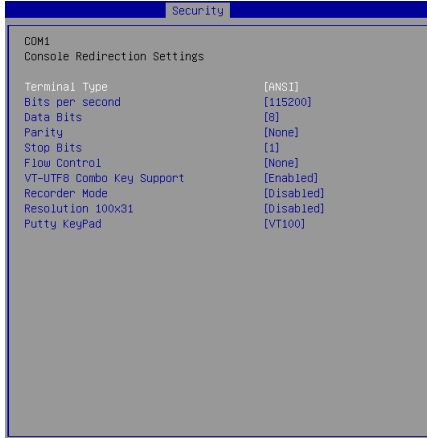

► **Terminal Type**

To operate the system's console redirection, you need a terminal supporting ANSI terminal protocol and a RS-232 null modem cable connected between the host system and terminal(s). This setting specifies the type of terminal device for console redirection.

► **Bits per second, Data Bits, Parity, Stop Bits**

This setting specifies the transfer rate (bits per second, data bits, parity, stop bits) of Console Redirection.

► **Flow Control**

Flow control is the process of managing the rate of data transmission between two nodes. It's the process of adjusting the flow of data from one device to another to ensure that the receiving device can handle all of the incoming data. This is particularly important where the sending device is capable of sending data much faster than the receiving device can receive it.

► **VT-UTF8 Combo Key Support**

This setting enables/disables the VT-UTF8 combination key support for ANSI/VT100 terminals.

► **Recorder Mode, Resolution 100x31**

These settings enable/disable the recorder mode and the resolution 100x31.

► **Putty Keypad**

PuTTY is a terminal emulator for Windows. This setting controls the numeric keypad for use in PuTTY.

► Legacy Console Redirection Settings



► Redirection COM Port

This setting specifies the COM port for redirection.

► Resolution

This setting specifies the redirection resolution of legacy OS.

► Redirect After POST

This setting determines whether or not to keep terminals' console redirection running after the POST has booted.

► **Console Redirection Settings**

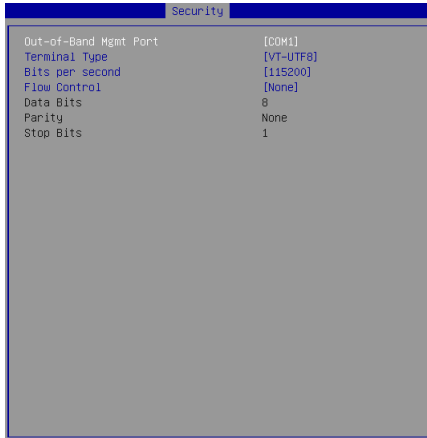

► **Out-of-Band Mgmt Port**

This setting specifies the Out-of-Band Management Port.

► **Terminal Type**

To operate the system's console redirection, you need a terminal supporting ANSI terminal protocol and a RS-232 null modem cable connected between the host system and terminal(s). This setting specifies the type of terminal device for console redirection.

► **Bits per second, Data Bits, Parity, Stop Bits**

This setting specifies the transfer rate (bits per second, data bits, parity, stop bits) of Console Redirection.

► **Flow Control**

Flow control is the process of managing the rate of data transmission between two nodes. It's the process of adjusting the flow of data from one device to another to ensure that the receiving device can handle all of the incoming data. This is particularly important where the sending device is capable of sending data much faster than the receiving device can receive it.

Chipset

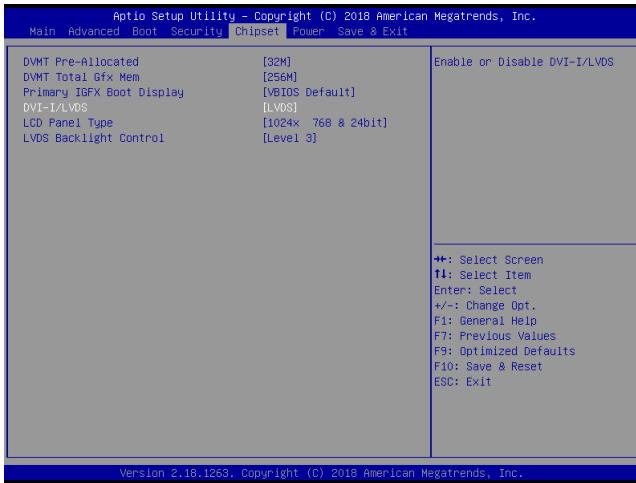

► DVMT Pre-Allocated

This setting selects DVMT 5.0 Pre-Allocated (Fixed) Graphics Memory size used by the Internal Graphics Device.

► DVMT Total Gfx Mem

This setting specifies the memory size for DVMT.

► Primary IGFX Boot Display

Use the field to select the type of device you want to use as the displays of the system.

► DVI-I/LVDS

This setting allows users to select between DVI-I and LVDS graphics interfaces.

► **LCD Panel Type**

This setting specifies the LCD panel resolution.

Important

- For the monitor to work properly, users need to select a resolution supported by the monitor.
- The optional DVI-I by MS-99C0 supports the following resolution:
 - 800 x 600 & 18bit
 - 1024 x 768 & 18bit
 - 1024 x 768 & 24bit
 - 1280 x 800 & 18bit
 - 1366 x 768 & 18bit
 - 1366 x 768 & 24bit
 - 1400 x 1050 & 24bit
 - 1600 x 900 & 24bit
 - 1600 x 1200 & 24bit
 - 1680 x 1050 & 24bit
 - 1920 x 1080 & 24bit
 - 1920 x 1200 & 24bit

► **LVDS Backlight Control**

This setting controls the intensity of the LVDS backlight.

Power

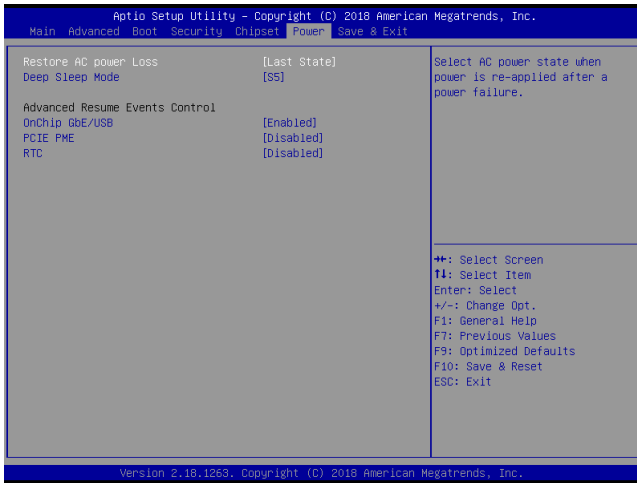

► Restore AC Power Loss

This setting specifies whether your system will reboot after a power failure or interrupt occurs. Available settings are:

[Power Off]	Leaves the computer in the power off state.
[Power On]	Leaves the computer in the power on state.
[Last State]	Restores the system to the previous status before power failure or interrupt occurred.

► Deep Sleep Mode

The setting enables/disables the Deep S5 power saving mode. S5 is almost the same as G3 Mechanical Off, except that the PSU still supplies power, at a minimum, to the power button to allow return to S0. A full reboot is required. No previous content is retained. Other components may remain powered so the computer can “wake” on input from the keyboard, clock, modem, LAN, or USB device.

**** Advanced Resume Events Control ****

▶ **Onchip GbE/USB**

The item allows the activity of the OnChip GbE/USB device to wake up the system from S3/S4 sleep state.

▶ **PCIE PME**

This field specifies whether the system will be awakened from power saving modes when activity or input signal of onboard PCIE PME is detected.

▶ **RTC**

When [Enabled], you can set the date and time at which the RTC (real-time clock) alarm awakens the system from suspend mode.

Save & Exit

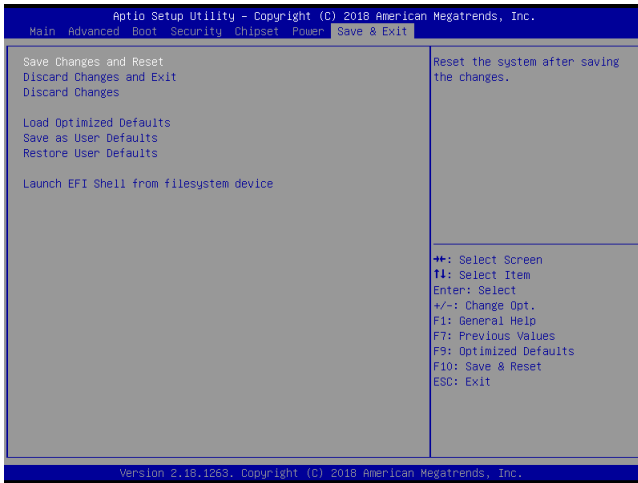

► Save Changes and Reset

Save changes to CMOS and reset the system.

► Discard Changes and Exit

Abandon all changes and exit the Setup Utility.

► Discard Changes

Abandon all changes.

► Load Optimized Defaults

Use this menu to load the default values set by the motherboard manufacturer specifically for optimal performance of the motherboard.

► Save as User Defaults

Save changes as the user's default profile.

► Restore User Defaults

Restore the user's default profile.

► Launch EFI Shell from filesystem device

This setting helps to launch the EFI Shell application from one of the available file system devices.

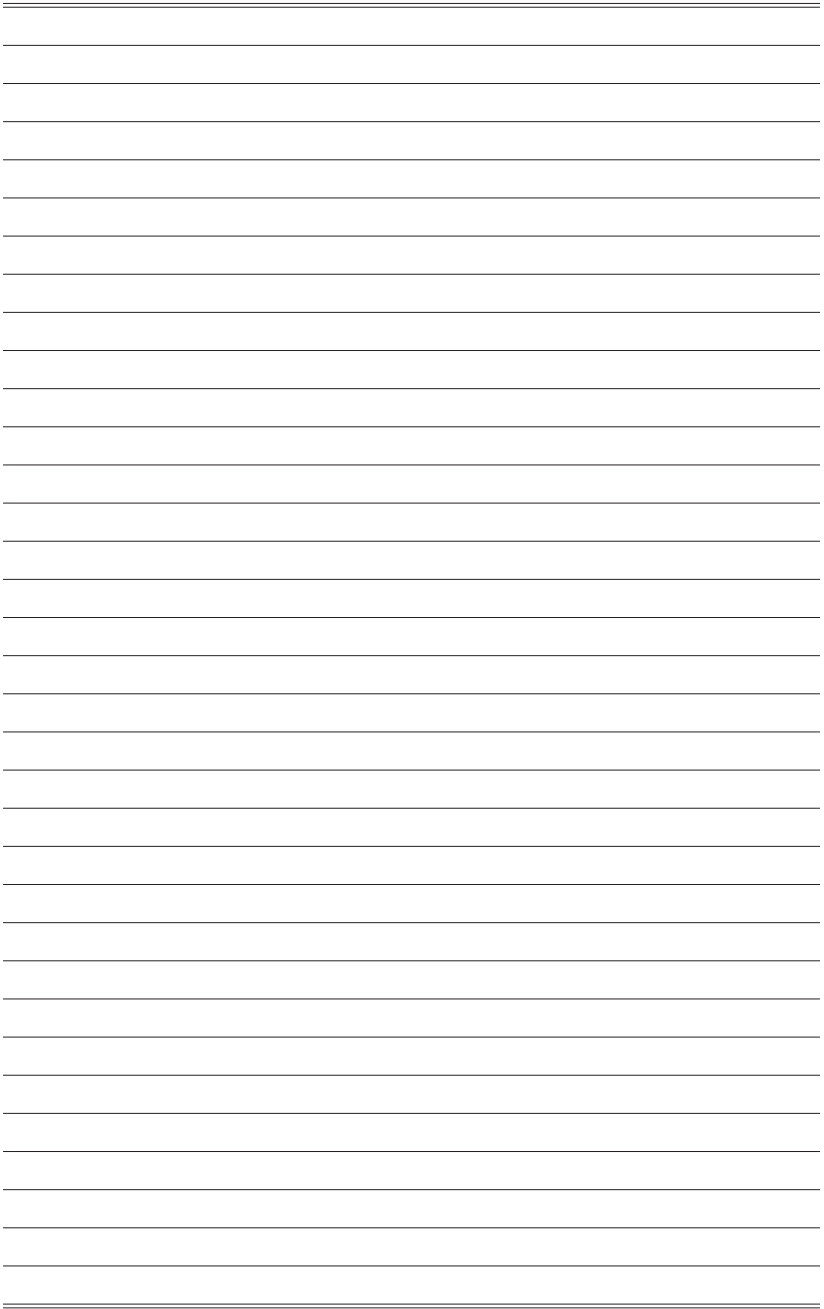

Appendix

GPIO WDT BKL Programming



This appendix provides WDT (Watch Dog Timer), GPIO (General Purpose Input/ Output) and LVDS Backlight programming guide.

Abstract

In this document, code examples based on C programming language are provided for customer interest. **Inportb**, **Outportb**, **Inportl** and **Outportl** are basic functions used for access IO ports and defined as following.

Inportb: Read a single 8-bit I/O port.

Outportb: Write a single byte to an 8-bit port.

Inportl: Reads a single 32-bit I/O port.

Outportl: Write a single long to a 32-bit port.

General Purposed IO

1. General Purposed IO – GPIO/DIO

The GPIO port configuration addresses are listed in the following table:

Name	IO Port	IO address	Name	IO Port	IO address
N_GPIO0	0x42	Bit 1	N_GPO0	0x41	Bit 0
N_GPIO1	0x42	Bit 2	N_GPO1	0x11	Bit 3
N_GPIO2	0x42	Bit 3	N_GPO2	0x11	Bit 6
N_GPIO3	0x22	Bit 3	N_GPO3	0x11	Bit 7
N_GPIO4	0x22	Bit 4	N_GPO4	0x21	Bit 0
N_GPIO5	0x22	Bit 5	N_GPO5	0x21	Bit 1
N_GPIO6	0x22	Bit 6	N_GPO6	0x21	Bit 2
N_GPIO7	0x22	Bit 7	N_GPO7	0x11	Bit 4

Note: GPIO should be accessed through controller device **0x6E** on SMBus. The associated access method in examples (**SMBus_ReadByte**, **SMBus_WriteByte**) are provided in part 4.

1.1 Set output value of GPO

1. Read the value from GPO port.
2. Set the value of GPO address.
3. Write the value back to GPO port.

Example: Set **N_GPO0** output “high”

```
val = SMBus_ReadByte (0x6E, 0x41); // Read value from N_GPO0 port through SMBus.
val = val | (1<<0); // Set N_GPO0 address (bit 0) to 1 (output “high”).
SMBus_WriteByte (0x6E, 0x41, val); // Write back to N_GPO0 port through SMBus.
```

Example: Set **N_GPO1** output “low”

```
val = SMBus_ReadByte (0x6E, 0x11); // Read value from N_GPO1 port through SMBus..
val = val & (~(1<<3)); // Set N_GPO1 address (bit 3) to 0 (output “low”).
SMBus_WriteByte (0x6E, 0x11, val); // Write back to N_GPO1 port through SMBus.
```

1.2 Read input value from GPI:

1. Read the value from GPI port.
2. Get the value of GPI address.

Example: Get **N_GPI2** input value.

```
val = SMBus_ReadByte (0x6E, 0x42); // Read value from N_GPI2 port through SMBus.
val = val & (1<<3); // Read N_GPI2 address (bit 3).
if (val) printf (“Input of N_GPI2 is High”);
else printf (“Input of N_GPI2 is Low”);
```

Example: Get **N_GPI6** input value.

```
val = SMBus_ReadByte (0x6E, 0x22); // Read value from N_GPI6 port through SMBus.
val = val & (1<<6); // Read N_GPI6 address (bit 6).
if (val) printf (“Input of N_GPI6 is High”);
else printf (“Input of N_GPI6 is Low”);
```

Watchdog Timer

2. Watchdog Timer – WDT

The base address (WDT_BASE) of WDT configuration registers is **0xA10**.

2.1 Set WDT Time Unit

```
val = Inportb (WDT_BASE + 0x05); // Read current WDT setting
val = val | 0x08; // minute mode. val = val & 0xF7 if second mode
Outportb (WDT_BASE + 0x05, val); // Write back WDT setting
```

2.2 Set WDT Time

```
Outportb (WDT_BASE + 0x06, Time); // Write WDT time, value 1 to 255.
```

2.3 Enable WDT

```
val = Inportb (WDT_BASE + 0x0A); // Read current WDT_PME setting
val = val | 0x01; // Enable WDT OUT: WDOUT_EN (bit 0) set to 1.
Outportb (WDT_BASE + 0x0A, val); // Write back WDT setting.
val = Inportb (WDT_BASE + 0x05); // Read current WDT setting
val = val | 0x20; // Enable WDT by set WD_EN (bit 5) to 1.
Outportb (WDT_BASE + 0x05, val); // Write back WDT setting.
```

2.4 Disable WDT

```
val = Inportb (WDT_BASE + 0x05); // Read current WDT setting
val = val & 0xDF; // Disable WDT by set WD_EN (bit 5) to 0.
Outportb (WDT_BASE + 0x05, val); // Write back WDT setting.
```

2.5 Check WDT Reset Flag

If the system has been reset by WDT function, this flag will set to 1.

```
val = Inportb (WDT_BASE + 0x05); // Read current WDT setting.
val = val & 0x40; // Check WDTMOUT_STS (bit 6).
if (val) printf ("timeout event occurred");
else printf ("timeout event not occurred");
```

2.6 Clear WDT Reset Flag

```
val = Inportb (WDT_BASE + 0x05); // Read current WDT setting
val = val | 0x40; // Set 1 to WDTMOUT_STS (bit 6);
Outportb (WDT_BASE + 0x05, val); // Write back WDT setting
```

LVDS Backlight Brightness Control

3. LVDS Backlight Brightness Control

The LVDS controller support 17 level of backlight brightness value from 0 (30%) to 16 (100%) and it is accessible through SMBus. The associated access method (**SMBus_ReadByte**, **SMBus_WriteByte**) are provided in part 4.

3.1 Set the Level of LVDS Backlight

1. Write **0xED** into address **0x7F** on SMBus device **0x42**.
2. Write desired backlight level from 0x0 (30%) to 0x10 (100%) into address **0x6E** on SMBus device **0x42**.

Example: Set LVDS backlight level to 0x10 (100%)

```
SMBus_WriteByte (0x42, 0x7F, 0xED);
```

```
SMBus_WriteByte (0x42, 0x6E, 0x10); // Set brightness to 100%
```

3.2 Read the Level of LVDS Backlight

1. Write **0xED** into address **0x7F** on SMBus device **0x42**.
2. Read current backlight level from address **0x6E** on SMBus device **0x42**.

Example: Get LVDS backlight level

```
SMBus_WriteByte (0x42, 0x7F, 0xED);
```

```
BKL_Value = SMBus_ReadByte (0x42, 0x6E);
```

SMBus Access

4. SMBus Access

The base address of SMBus must be known before access. The relevant bus and device information are as following.

```
#define IO_SC          0xCF8
#define IO_DA          0xCFC
#define PCIBASEADDRESS 0x8000000
#define PCI_BUS_NUM    0
#define PCI_DEV_NUM    31
#define PCI_FUN_NUM    4
```

4.1 Get SMBus Base Address

```
int SMBUS_BASE;
int DATA_ADDR = PCIBASEADDRESS + (PCI_BUS_NUM<<16) +
                (PCI_DEV_NUM<<11) +
                (PCI_FUN_NUM<<8);

Outportl (DATA_ADDR + 0x20, IO_SC);
SMBUS_BASE = Inportl (IO_DA) & 0xfffffff;
```

4.2 SMBus_ReadByte (char DEVID, char offset)

Read the value of OFFSET from SMBus device DEVID.

```
Outportb (LOWORD (SMBUS_BASE), 0xFE);
Outportb (LOWORD (SMBUS_BASE) + 0x04, DEVID + 1); //out Base + 04, (DEVID + 1)
Outportb (LOWORD (SMBUS_BASE) + 0x03, OFFSET); //out Base + 03, OFFSET
Outportb (LOWORD (SMBUS_BASE) + 0x02, 0x48); //out Base + 02, 48H
mdelay (20); //delay 20ms to let data ready
while ((Inportl (SMBUS_BASE) & 0x01) != 0); //wait SMBUS ready
SMB_DATA = Inportb (LOWORD (SMBUS_BASE) + 0x05); //input Base + 05
```

4.3 SMBus_WriteByte (char DEVID, char offset, char DATA)

Write DATA to OFFSET on SMBus device DEVID.

```
Outportb (LOWORD (SMBUS_BASE), 0xFE);
Outportb (LOWORD (SMBUS_BASE) + 0x04, DEVID); //out Base + 04, (DEVID)
Outportb (LOWORD (SMBUS_BASE) + 0x03, OFFSET); //out Base + 03, OFFSET
Outportb (LOWORD (SMBUS_BASE) + 0x05, DATA); //out Base + 05, DATA
Outportb (LOWORD (SMBUS_BASE) + 0x02, 0x48); //out Base + 02, 48H
mdelay (20); //wait 20ms
```