



CUSTOMER

ORDERING DATA :

9 04 - ** * * ** - * ** 1 2 3 4 5 6 7	AVAILABLE PRODUCT
1. PRODUCT MAJOR SERIES :	04: D-SUB(DP) CONNECTOR SOLDER POT
2. CONTACT POSITION :	01 : 9 POSITIONS 02 : 15 POSITIONS 03 : 25 POSITIONS 04: 37 POSITIONS
3. MALE:	1 : MALE
4. INSULATOR COLOR :	1.White 2.Black 3.Blue
5. IRREGULAR CHANGES :	SEE:ALL CLINCH-NUTS ARE 4-40 INTERNAL THREADS
6. Environmental protection :	1.ROHS 2.SONY
7. CONTACT PLATING :	01 : MATING AREA : 0.8~50u" Au Min , BRASS(FOR 15,26,44,62 POSITIONS) TERMINATION AREA : TIN-LEAD ALL UNDERPLATED : NICKEL
SHELL PLATING :	FRONT SHELL PLATING :NICKEL PLATED (100u"-120u" NICKEL OVER 50u"-80u" COPPER) (FOR 9,15,25,37 POSITIONS) BACK SHELL PLATING :TIN PLATED (100u"-120u" TIN OVER 50u"-80u" COPPER) (FOR 9,15,25,37 POSITIONS)

REV.	ECN. NO.	DESCRIPTION	ISSUED	APPROVED
1	2	3	4	5
B	B:1	将4.7±0.30尺寸变更为4.8±0.25	2010/5/11 张利平	2010/5/11 张利平

TOLERANCE :		TEL	0755-89488808	 3rd ANGLE PROJECTION	 SHENZHEN YINGGANG TECHNOLOGY CO., LTD. 深圳市盈钢科技有限公司
X. ± 0.40 .X ± 0.35 .XX ± 0.25	X. ±3" .X. ±2"	FAX	0755-89488865		
DATE		DRAWN		CHECKED	
APPROVED		CONFIDENTIAL		TITLE	
SIZE A4		VERSION B		PART NO. 9XX-XXXX-XXX	
SCALE 1:1		UNIT MM		SHEET 2/3	

A	1	2	3	4	5	6	7	8
B	1	2	3	4	5	6	7	8
C	1	2	3	4	5	6	7	8
D	1	2	3	4	5	6	7	8
E	1	2	3	4	5	6	7	8
F	1	2	3	4	5	6	7	8

CUSTOMER

ALL CLINCH-NUTS ARE 4-40 INTERNAL THERADS

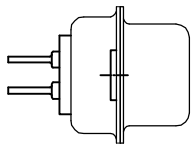

09:NO HEX SCREW LOCKS

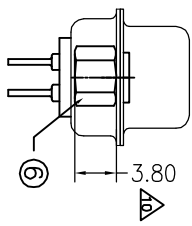

13: RIVETING 2X4-40 BACK NUT SCREW LOCKS

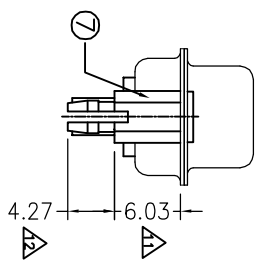

20:RIVETING 2X4-40 HARPOON

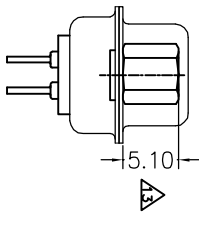

14:RIVETING 2X4-40 FRONT NUT SCREW LOCKS

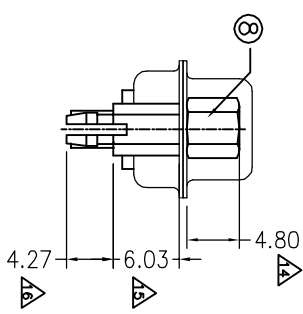

19: RIVETING 2X4-40 HARPOON LOCK SCREW

A	1	2	3	4	5	6	7	8	
B	ALL CLINCH-NUTS ARE 4-40 INTERNAL THERADS								
C	<p>09:NO HEX SCREW LOCKS 13: RIVETING 2X4-40 BACK NUT SCREW LOCKS 20:RIVETING 2X4-40 HARPOON</p>								
D	<p>14:RIVETING 2X4-40 FRONT NUT SCREW LOCKS 19: RIVETING 2X4-40 HARPOON LOCK SCREW</p>								
E	<p>TOLERANCE : X. ± 0.40 X. ± 3" .X ± 0.35 .X. ± 2" .XX ± 0.25</p>								
F	REV. B		ECN. NO. B:1 将4.7±0.30尺寸变更为4.8±0.25		2010/5/11 张利平		2010/5/11 张利平		
DESCRIPTION					3rd ANGLE PROJECTION			CONFIDENTIAL	
REV. 1		ECN. NO. 2		ISSUED 张利平		APPROVED 张利平		SCALE 1:1 UNIT MM SHEET 3/3	
TEL 0755-89488808		FAX 0755-89488865		DATE		DRAWN		CHECKED	
SHENZHEN YINGANG TECHNOLOGY CO., LTD.		深圳市盈钢科技有限公司		PART NO. 9XX-XXXX-XXX		TITLE DP MALE SERIES PLUG STRAIGHT PCB MOUNT		VERSION B	
CUSS NO.		CUSS NO.		SHEET 3/3		SHEET 3/3		SHEET 3/3	