

4-4 Schottky Barrier Diodes

V _{RM} (V)	I _F (AV) (A)	Package Axial (Body Diameter/Lead Diameter)	Part Number	I _{FSM} (A)	T _J (°C)	T _{stg} (°C)	V _F (V) max	I _F (A)	I _R (mA)	I _R (H) (mA)	T _J (°C)	R _{th(j-l)} R _{th(j-c)} (°C/W)	Mass (g)
				50Hz Single Half Sine Wave					V _R =V _{RM} max	V _R =V _{RM} max			
60	0.7	Axial(φ2.4/φ0.6)	AK 06	10	-40 to +150		0.62	0.7	1.0	30	150	22	0.13
	0.7	Axial(φ2.7/φ0.6)	EK 06	10	-40 to +150		0.62	0.7	1.0	30	150	20	0.3
	1.5	Axial(φ2.7/φ0.78)	EK 16	25	-40 to +150		0.62	1.5	1.0	55	150	17	0.3
	1.5	Axial(φ4.0/φ0.78)	RK 16	25	-40 to +150		0.62	1.5	1.0	55	150	15	0.45
	2.0	Axial(φ4.0/φ0.98)	RK 36	40	-40 to +150		0.62	2.0	2.0	70	150(Ta)	12	0.6
	3.5	Axial(φ6.5/φ1.4)	RK 46	70	-40 to +150		0.62	3.5	3.0	125	150	8.0	1.2
	4.0	TO-220F(Center-tap)	FMB-26	40	-40 to +150		0.62	2.0	2.0	70	150	4.0	2.1
	6.0	TO-220F2Pin	FMB-G16L	50	-40 to +150		0.72	6.0	5.0	200	150	4.0	2.1
	10	TO-220F(Center-tap)	FMW-2106	100	-40 to +150		0.70	5.0	3.0	125	150	4.0	2.1
	15	TO-220F(Center-tap)	FMW-2156	100	-40 to +150		0.70	7.5	5.0	175	150	4.0	2.1
	20	TO-220F(Center-tap)	FMW-2206	120	-40 to +150		0.70	10	1.0	250	150	4.0	2.1
	30	TO-220F(Center-tap)	FMB-2306	150	-40 to +150		0.70	15	8.0	400	150	4.0	2.1
30	TO-3PF(Center-tap)	FMW-4306	150	-40 to +150		0.70	15	3.0	350	150	2.0	6.5	
90	0.7	Axial(φ2.4/φ0.6)	AK 09	10	-40 to +150		0.81	0.7	1.0	30	150	22	0.13
	0.7	Axial(φ2.7/φ0.6)	EK 09	10	-40 to +150		0.81	0.7	1.0	30	150	20	0.3
	1.5	Axial(φ2.7/φ0.78)	EK 19	40	-40 to +150		0.81	1.5	2.0	55	150	17	0.3
	1.5	Axial(φ4.0/φ0.78)	RK 19	40	-40 to +150		0.81	1.5	2.0	55	150	15	0.45
	2.0	Axial(φ4.0/φ0.98)	RK 39	50	-40 to +150		0.81	2.0	3.0	70	150(Ta)	12	0.6
	3.5	Axial(φ6.5/φ1.4)	RK 49	60	-40 to +150		0.81	3.5	5.0	125	150	8.0	1.2
	4.0	TO-220F(Center-tap)	FMB-29	50	-40 to +150		0.81	2.0	3.0	55	150	4.0	2.1
	4.0	TO-220F2Pin	FMB-G19L	60	-40 to +150		0.81	4.0	5.0	125	150	4.0	2.1
8.0	TO-220F(Center-tap)	FMB-29L	60	-40 to +150		0.81	4.0	5.0	125	150(Ta)	4.0	2.1	

Low V_F "A Series"

●Surface-Mount

V _{RM} (V)	I _F (AV) (A)	Package	Part Number	I _{FSM} (A)	T _J (°C)	T _{stg} (°C)	V _F (V) max	I _F (A)	I _R (mA)	I _R (H) (mA)	T _J (°C)	R _{th(j-l)} R _{th(j-c)} (°C/W)	Mass (g)
				50Hz Single Half Sine Wave					V _R =V _{RM} max	V _R =V _{RM} max			
30	1.0	Surface-Mount (SJP)	SJPA-D3	30	-40 to +125		0.36	1.0	1.5	70	100(Ta)	20	0.072
	2.0	Surface-Mount (SJP)	SJPA-H3*	40	-40 to +125		0.36	2.0	3.0	140	100(Ta)	20	0.072
	3.0	Surface-Mount (SJP)	SJPA-L3	70	-40 to +125		0.36	3.0	4.5	210	100	20	0.072

*Under development

●Thru-Hole

V _{RM} (V)	I _F (AV) (A)	Package Axial (Body Diameter/Lead Diameter)	Part Number	I _{FSM} (A)	T _J (°C)	T _{stg} (°C)	V _F (V) max	I _F (A)	I _R (mA)	I _R (H) (mA)	T _J (°C)	R _{th(j-l)} R _{th(j-c)} (°C/W)	Mass (g)
				50Hz Single Half Sine Wave					V _R =V _{RM} max	V _R =V _{RM} max			
30	2.0	Axial(φ4.0/φ0.78)	RA 13	50	-40 to +125		0.36	2.0	3.0	140	100	15	0.45

• No. 13 Axial ($\phi 4.0/\phi 0.78$)

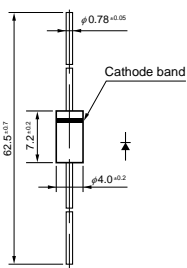

• No. 14 Axial ($\phi 4.0/\phi 0.98$)

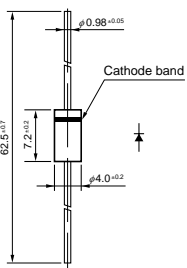

• No. 15 Axial ($\phi 6.5/\phi 1.4$)

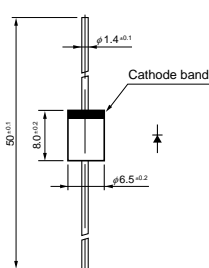

• No. 16 TO-220F (Two Elements)

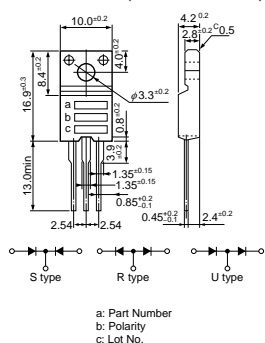

• No. 17 TO-220F (Center-tap)

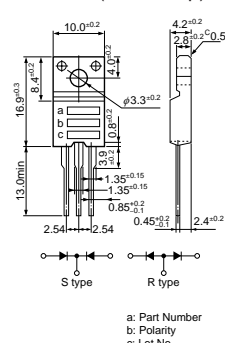

• No. 18 TO-220F2Pin

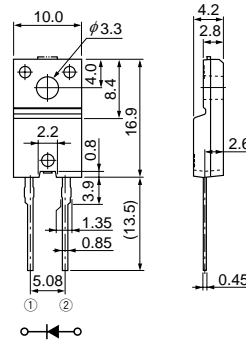

• No. 19 TO-220F2Pin (Two Elements)

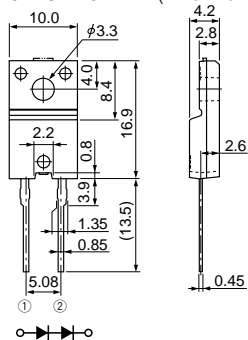

• No. 20 TO-3PF

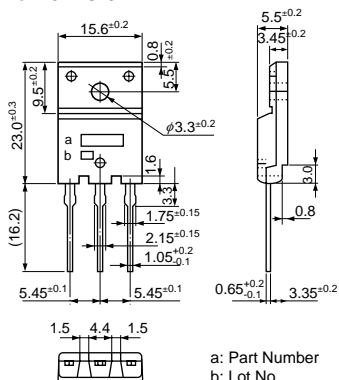

• No. 21 TO-3PF2Pin

